

# PRODUCT MANUAL



## ROYAL PRESTIGE<sup>®</sup> JUICE EXTRACTOR

**IMPORTANT: To prevent personal injury and/or property damage,  
read and follow the instructions and warnings in this Product Manual.**

SAVE THESE INSTRUCTIONS • FOR QUESTIONS OR COMMENTS, SEE REVERSE FOR YOUR SERVICE CENTER CONTACT NUMBER.  
FOR HOUSEHOLD USE ONLY.

# ROYAL PRESTIGE® JUICE EXTRACTOR

## Table of Contents

Introduction . . . . .	2
Important Safeguards . . . . .	3
Product Diagram . . . . .	4
Before you Start. . . . .	6
Operation . . . . .	8
Cleaning and Care Instructions . . . . .	15
Troubleshooting/FAQ . . . . .	20
Technical Information . . . . .	23
Customer Service . . . . .	24

READ ALL INSTRUCTIONS BEFORE USE

## Introduction

Welcome and congratulations on purchasing your Royal Prestige® Juice Extractor. Please be sure to read this manual in its entirety before using your Royal Prestige® Juice Extractor to ensure that you have an enjoyable experience. The valuable information contained in this manual will provide an overview of the product, some helpful hints to get you started, as well as trouble-shooting tips should you have issues with this product in the future.



ROYAL PRESTIGE®

# ROYAL PRESTIGE® JUICE EXTRACTOR

The following precautions are provided to ensure the safety of the user. Please carefully read through the precautions and exercise care when using the appliance.

- ⚠ Warning: This label warns of the risk of death or severe injuries.
- ⊘ Prohibited.
- 🔧 Do not disassemble.
- ⓘ Caution: This label warns of the risk of injuries or appliance damage.
- 🛑 Must take action.

## Important Safeguards

This appliance is for household use only. Please carefully follow the instructions in the manual. (This appliance cannot be covered under warranty if the product is abnormally or commercially used). Save the instruction manual for future reference. These instructions are also available on [www.royalprestige.com](http://www.royalprestige.com). If the appliance is given away as a gift, please include the manual with the product.

**When using electrical appliances, basic safety precautions should be followed including the following:**

READ ALL INSTRUCTIONS.	
<b>Risk of Electric Shock or Fire</b>	<ul style="list-style-type: none"> <li>Do not immerse motor base in water or other liquid.</li> <li>The use of attachments not recommended or sold by the manufacturer may cause fire, electric shock or injury.</li> <li>Do not spray water or flammable sprays near the appliance.</li> </ul>
<b>Risk of Injury</b>	<ul style="list-style-type: none"> <li>Close supervision is necessary when any appliance is used by or near children.</li> <li>Avoid contact with any moving parts.</li> <li>Always make sure the Hopper is closed securely in place before motor is turned on. Do not open the Hopper while Juice Extractor is in operation.</li> <li>Turn switch to OFF position after each use of your Juice Extractor. Make sure the motor stops completely before disassembling.</li> <li>Do not put fingers or other objects into the Hopper during operation. If food becomes lodged, use pusher or another piece of fruit or vegetable to push it down. When this method does not work, turn the motor off and disassemble Juice Extractor to remove the remaining food.</li> <li>This device is not intended for use by persons (including children) whose physical, sensory or mental abilities are different or reduced, or who lack experience or knowledge, unless such persons receive supervision or training for the operation of the device by a person responsible for your safety.</li> <li>Children should be supervised to ensure that they do not use the device as a toy.</li> </ul>
<b>Dangers Related to Misuse</b>	<ul style="list-style-type: none"> <li>Unplug from wall outlet when not in use before putting on or taking off parts, and before cleaning.</li> <li>Do not operate any appliance with a damaged cord or plug, or after the appliance malfunctions or damaged in any manner. Return appliance to customer support for examination and/or repair.</li> <li>Do not use outdoors.</li> <li>Do not let cord hang over edge of table, counter, or another surface area.</li> <li>Do not use the appliance if the rotation wiper is damaged.</li> <li>Do not operate without the pulp cup in place.</li> <li>Do not alter or modify the appliance in any way.</li> <li>Do not use the appliance for anything other than its intended purpose as described in the manual.</li> <li>The appliance should be used for a limited period of time to prevent overheating.</li> <li>Do not use the appliance on an uneven surface.</li> <li>Do not put the Juice Extractor parts in the dishwasher or extremely hot water.</li> <li>Do not use any hazardous chemicals to clean the appliance.</li> </ul>



# ROYAL PRESTIGE® JUICE EXTRACTOR

## Product Diagram

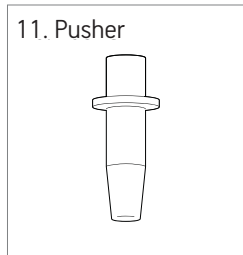
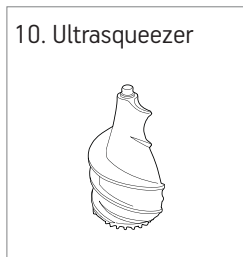
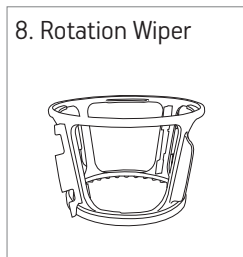
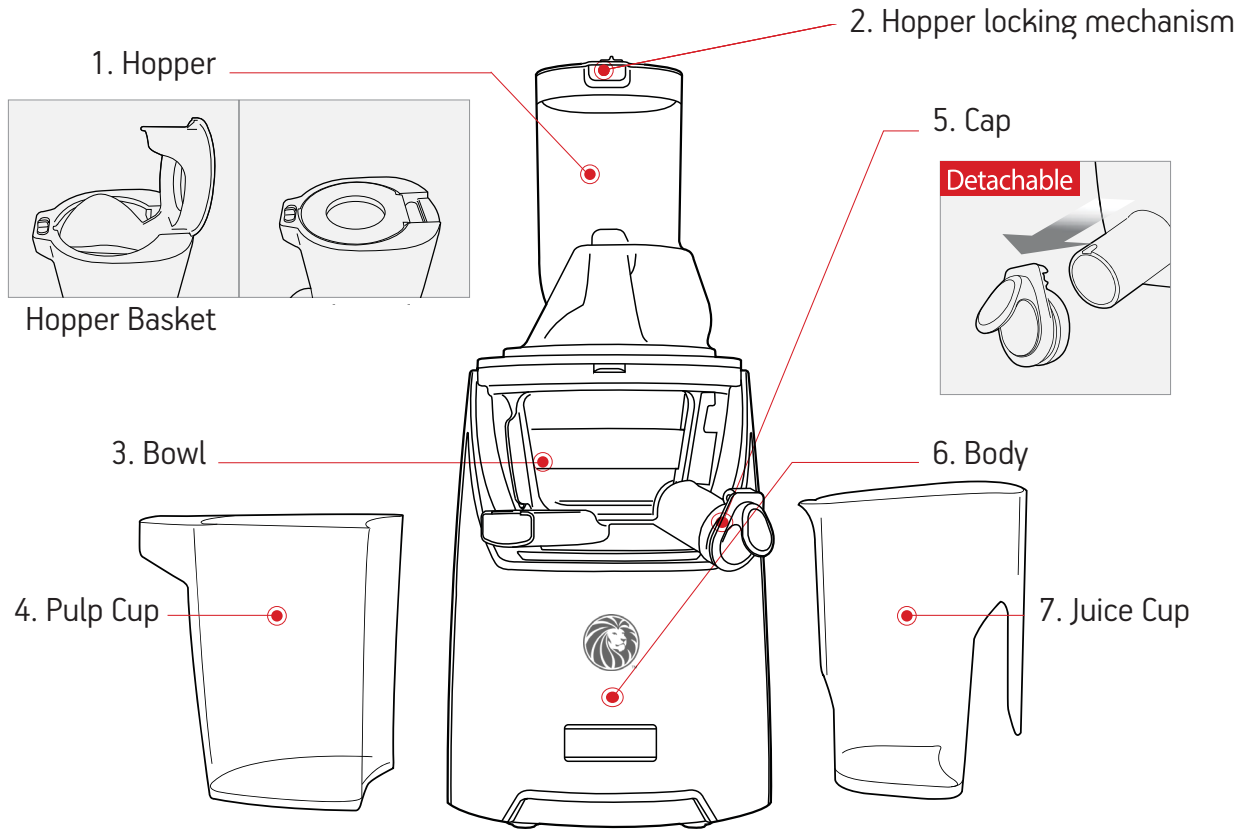

# ROYAL PRESTIGE® JUICE EXTRACTOR

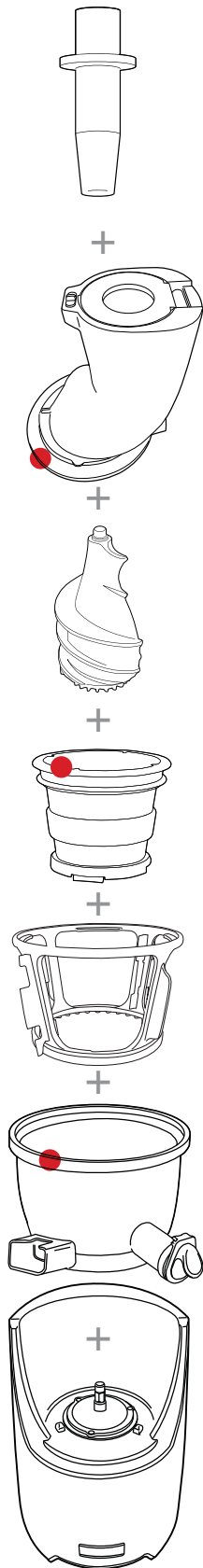

\*The products illustrated/photographed in this manual may vary slightly from the actual product.

## STEP 1

Top-set Assembly

Align the red dots ● on each part and assemble all the pieces in the order shown. Once assembled, turn the Hopper clockwise to close.

## STEP 2

Top-set and base assembly

Assemble the entire top-set onto the base ensuring the arrow symbol ▼ on the Hopper is aligned with the arrow symbol ▲ on the base.



# ROYAL PRESTIGE® JUICE EXTRACTOR

## Before You Start

### Check Before Operating

Wash the parts before first use.

### STEP 1 Top-set Assembly

- 1** Assemble the strainer into the rotation wiper, then place this assembly into the bowl ensuring the red dot ● on the strainer is aligned with the red dot ● on the bowl.

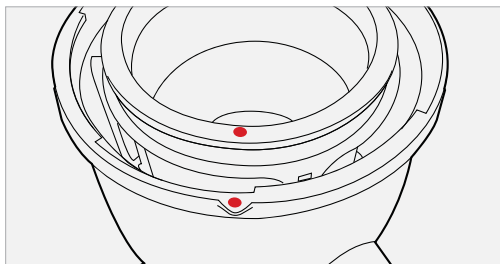
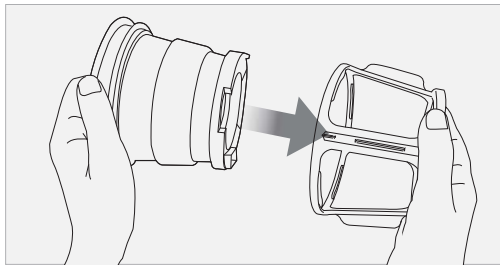

- 2** Place the Ultrasqueezer into the strainer. Turn and press down on it until it clicks into place.

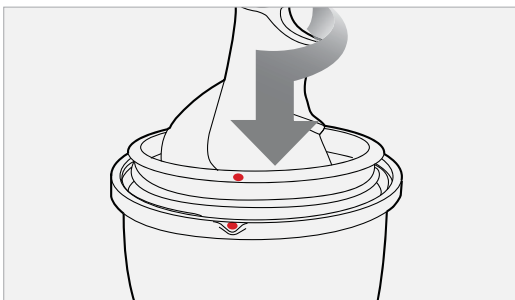

Note: The Ultrasqueezer needs to be locked in place in order to close the Hopper.

- 3** Place the Hopper onto the bowl aligning the red dot ● on the Hopper with the red dot ● on the bowl. Turn clockwise to close, aligning the red dot ● on the Hopper with the close mark ||.

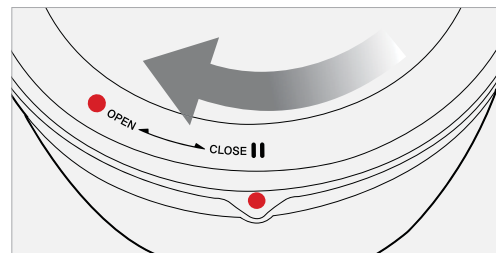
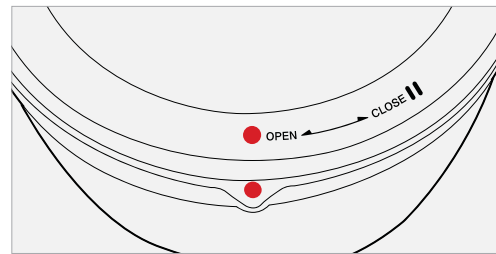

## STEP 2 Top-set and Base Assembly

- 4** Place the top-set on top of the base.  
Align the arrow ▼ on the Hopper with  
the arrow ▲ (open) on the base.

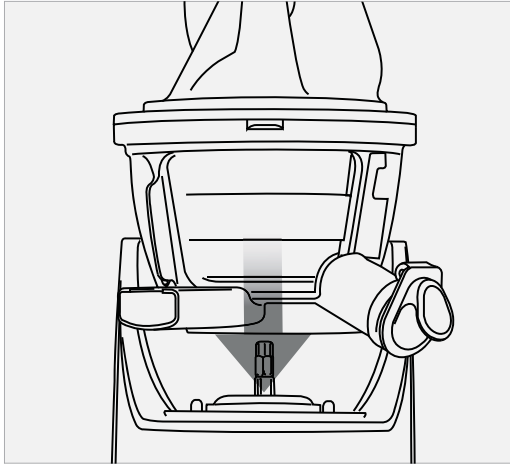

Note: The Juice Extractor will not operate if parts are not assembled properly.

- TIP** For easy assembly hold the Hopper with both hands and turn clockwise as shown in the illustration.

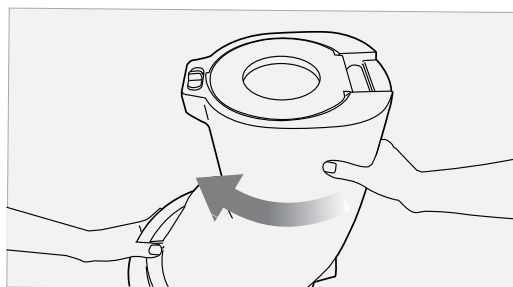
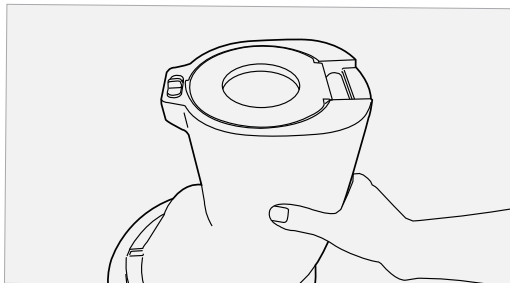

- 5** Open/Close mark on the top-set.

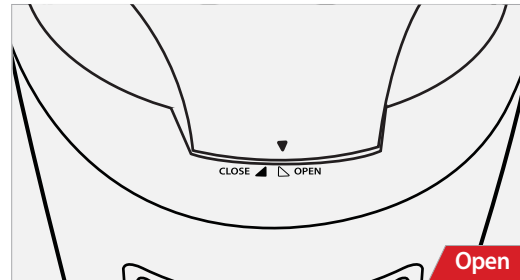

- 6** Place the pulp cup under the pulp spout and place the juice cup under the juice spout as shown in the illustration. Pusher is optional.



# ROYAL PRESTIGE® JUICE EXTRACTOR

## Operation

### STEP 1

After preparing the ingredients, plug the power cord into a wall outlet.

Note: • Do not touch the power cord with wet hands. It may cause electrical shock, short-circuit, or fire.  
• Check the safety of the wall outlet.

### STEP 2

Press the FORWARD button to operate.

Note: • Forward: Pulls down and slowly presses the ingredients.  
• Reverse: Pushes the ingredients back up to dislodge them.

If the ingredients become jammed in the Ultrasqueezer and the Hopper does not open, press the OFF button. Then press and hold the REVERSE button until the ingredients become dislodged. Repeat REVERSE - OFF - FORWARD as often as needed to achieve the desired result.

## If the Juice Extractor stops during operation

Switch the button to OFF position then press and hold the REVERSE button until the ingredients become dislodged. Repeat REVERSE - OFF - FORWARD as needed.

FORWARD : Pulls down the food  
OFF : Stops the operation  
REVERSE : Pushes the food back up

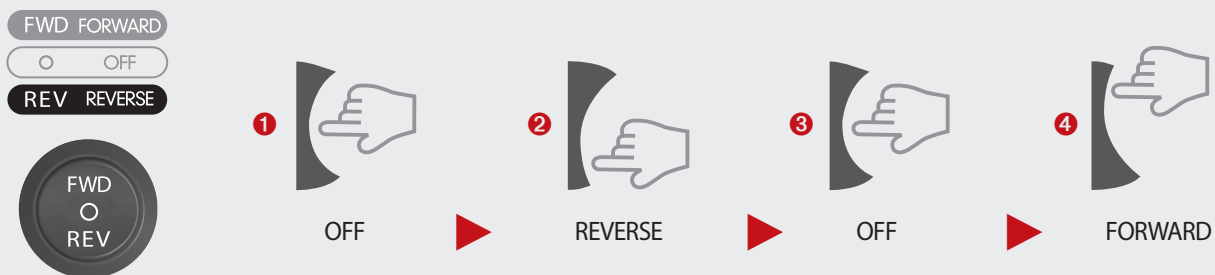

Note | REVERSE: Pushes the ingredients back up to dislodge them.  
The REVERSE button only works while holding down the switch.

Switch OFF ensuring that the Juice Extractor comes to a complete stop. Then press REVERSE. Hold the REVERSE button for 2-3 seconds and release. Repeat as needed. Let the Juice Extractor stop completely before using the REVERSE button to prevent malfunction.

If the Juice Extractor does not work after these steps, disassemble and clean the parts before operating the Juice Extractor again.





## STEP 3 Insert the prepared ingredients one piece at a time.

- Note:
- Prepare ingredients for optimal extraction.
  - If a large quantity of ingredients is put into the Hopper, it can cause the Juice Extractor to stop.
  - Insert the ingredients one piece at a time.
  - Remove hard seeds or pits in fruits. When juicing frozen fruits, completely thaw before juicing.

Tip:



**Hard vegetables & high fiber foods** | (E.g. carrots, beets, & spinach)

- Tough and fibrous ingredients: Cut to size.
- Fibrous leafy vegetables (celery, kale, collard greens, etc.): Cut the stems to size.

Tip:



**Soft Fruits & Vegetables** | (E.g. apples, oranges & tomatoes)

- Soft ingredients: Cut ingredients to size. Insert the prepared ingredients into the feed basket and push down the ingredient with the basket lid to extract.

## STEP 4 Use the cap to make mixed juices, stop juice from dripping, or rinse between different juices.



- Tip:
- Juicing with the cap closed makes various mixed juice creations when different fruits and vegetables, milk, banana, beans etc. are selected.
  - After juicing, close the cap to stop the juice from dripping, especially when disassembling the bowl off the base.
  - When making different juices quickly rinse away any leftover flavors by running a glass of water in the Juice Extractor with the cap closed.

- Note :
- **Leave the cap open when juicing ingredients that create excessive foam during extraction (e.g. apples, celery).**
  - Pay close attention when operating with the cap closed. Juice may overflow if the juice collected in the bowl exceeds its capacity marked on the bowl.

## STEP 5 After juice and pulp are completely extracted, switch the unit OFF.

- Note:
- If the remaining ingredients in the bowl have not been extracted completely, the Hopper may not open easily. **After each extraction, run the Juice Extractor for an additional 30 seconds to let it extract the remaining pulp.**
  - When the Hopper is stuck, press the REVERSE - OFF - FORWARD button in this order; switching back and forth 2 or 3 times to dislodge the ingredients. Then place hands on top of the Hopper's lid and firmly press down, while simultaneously turning it counter clockwise to open.
    - » **Depending on the ingredients, pour water down the Hopper to rinse out the interior of the bowl and then attempt to remove it.**



# ROYAL PRESTIGE® JUICE EXTRACTOR

## Helpful Hints

1. **Operating the Juice Extractor without ingredients can cause damage to the Ultrasqueezer.**
2. **Do not continuously operate the Juice Extractor for more than 30 minutes.**  
This can overheat the motor and damage it. After continuous use, let the Juice Extractor rest for 30 minutes to cool down before starting another session.
3. **Do not put fingers or other objects into the Hopper. Always use provided pusher when needed.**  
If other objects are inserted into the Hopper during operation, they can get stuck and damage the Juice Extractor parts and/or cause injury.
4. **Do not put dried or hard ingredients like whole grains, fruits with hard seeds or ice into the Juice Extractor.**  
These may damage the parts (e.g. bowl, Ultrasqueezer, and strainer).
  - Beans or grains can be used if soaked overnight or boiled.
  - Fruits with pits and hard seeds must be pitted before juicing (e.g. nectarines, peaches, mangoes and cherries).
  - **When using frozen fruits with small seeds such as grapes, completely thaw before inserting them into the Juice Extractor.**
5. Do not use ingredients containing excessive amounts of vegetable oil or animal fat. Do not use the Juice Extractor to extract vegetable oil from ingredients.  
**If vegetable/animal oil gets on the Ultrasqueezer, it may reduce performance and even damage the part.**
6. Do not reinsert the extracted pulp into the Juice Extractor. This can cause the unit to stop or cause the Hopper not to open.
7. After juicing ingredients with seeds like grapes, thoroughly clean all the crevices on the bottom of the Ultrasqueezer.

Juice Extractor damaged due to owner negligence or from not following the instructions in this manual will void the warranty.

**DO NOT put the following ingredients into the Juice Extractor:**

<b>Hard seeds</b>	Peach, nectarines, apricot, plum, mango, etc. <b>Remove hard seeds or pits from the ingredients before juicing</b>
<b>Hard or inedible skins</b>	Pineapple, melon, mango, orange, etc. <b>Peel the skin from the ingredients before juicing.</b>
<b>Frozen fruits or ice</b>	Frozen strawberry, blueberry, raspberry, etc. <b>Completely thaw frozen fruits before juicing. Do not use ice.</b>



<b>Vegetable/animal oil</b>	Sesame seed, butter, margarine, etc. <b>Do not extract ingredients containing vegetable or animal oil. This can reduce performance and even damage the Juice Extractor.</b>
<b>Others</b>	Coconut, sugarcane, whole grains, etc. <b>Do not extract ingredients with no water content.</b>

Experience the best quality juice by understanding each ingredient’s characteristics and knowing the optimal way of handling them.

The Juice Extractor is an innovative product that uses a patented slow-speed juicing technology to efficiently extract the juice from ingredients. The Juice Extractor is designed to obtain the best result from ingredients with firm composition and with high water content. For best result, each ingredient should be prepared and extracted depending on its characteristics and properties.

## Tips On Ingredients

<b>Before Operating</b>	<ul style="list-style-type: none"> <li>• Before Operating: If the Juice Extractor is jammed or if the Hopper does not open, press the REVERSE button and hold until the ingredient becomes dislodged. Repeat REVERSE-OFF-FORWARD as needed.</li> <li>• Continue operating the Juice Extractor until all the ingredients in the bowl are extracted. The Hopper may not open easily if there is a lot of pulp remaining in the Juice Extractor.</li> <li>• Every ingredient yields different amounts of juice.</li> </ul>
<b>Juice Yield</b>	<ul style="list-style-type: none"> <li>• For the optimal extraction and maximum juice yield, cut the ingredients following the guidelines given in this section.</li> <li>• <b>Insert ingredients slowly, monitoring how they are extracted.</b> The juice yield may vary depending on the juicing speed.</li> </ul>
<b>Adjusting the Amount of Pulp in the Juice</b>	<ul style="list-style-type: none"> <li>• Depending on the ingredient, you may get extra pulp when juicing continuously.</li> <li>• To reduce the amount of pulp, disassemble the top-set and wash frequently.</li> </ul>



# ROYAL PRESTIGE® JUICE EXTRACTOR

## SOFT FRUITS AND VEGETABLES (e.g. oranges, tomatoes):

- Peel the skin off oranges, and for tomatoes and apples, take out the stem.
- If the ingredients are larger than the Hopper, cut the ingredients into pieces that will fit into it.
- Fruits with seeds must be pitted before extraction. Cut to size then slowly insert them down the Hopper.

### PREPARATION TIPS:

- Cut ingredients cut to size.

### EXTRACTION TIPS:

- Slowly insert the ingredients, one piece at a time.
- Use the pusher to push the ingredients down the Hopper. (The pusher also helps prevent juice from spraying out of the Hopper when extracting ingredients with high water content.)
- Leave the cap open when juicing ingredients that create excessive foam during extraction, like apples and celery. (Foam can accumulate if operated with the cap closed.)
- It is recommended that the extracted juice be consumed within 48 hours after extracting. Depending on the density of the ingredients, the extracted juice can gradually separate into layers over time.
- If there is an excessive amount of foam, use a mesh strainer to separate it from the juice.

## HARD FRUITS AND VEGETABLES (e.g. carrots, potatoes, beets):

- Hard fruits and vegetables may put excess strain onto the motor and cause it to stall.
- To increase the juice yield, juice fruits and vegetables with high water content.

### PREPARATION TIPS:

- Slice the ingredients cut to size.



## EXTRACTION TIPS:

- Slowly insert the ingredients, one at a time.
- **Pace the juicing speed, ensuring each ingredient is thoroughly extracted.**
- To maximize the juice yield, juice ingredients with high water content.

## INGREDIENTS WITH SMALL SEEDS (e.g. raspberry, pomegranate, grape):

Slowly insert ingredients with small seeds to prevent clogging the Strainer.

- Insert ingredients slowly to minimize the amount of leftover seeds in the Strainer.
- For best results, use ingredients with a higher amount of fluid (e.g. apple, pear).

## PREPARATION TIPS:

- When juicing frozen ingredients, make sure they are completely thawed (e.g. raspberry, strawberry).
- Rinse ingredients thoroughly. Remove all stems.
- For pomegranate, discard the skin and juice only the inner part.

## EXTRACTION TIPS:

- Depending on the size of the grape, insert 3-5 grapes at a time while monitoring the extraction result.
- For ingredients like pomegranate and raspberry, insert about 1 tablespoon (5g) at a time.
- Frozen ingredients usually lose a significant amount of fluid from thawing. When juicing, mix milk or yogurt to balance the fluid lost.

## ⓘ CAUTION:

If the Hopper does not open due to excessive amount of small seeds left in the bowl, continuously run the Juice Extractor for 30 seconds to extract any leftover seeds. If the Hopper is still stuck, repeat REVERSE - OFF- FORWARD until the ingredients become dislodged. Then twist the Hopper to open while pushing downwards with palms. (Depending on the ingredient, pour some water down the Hopper for a quick rinse to help dislodge.)



# ROYAL PRESTIGE® JUICE EXTRACTOR

## FIBROUS AND/OR TOUGH LEAFY INGREDIENTS (e.g. celery, kale, pineapple):

Fibrous ingredients like celery and kale should be cut to size.

- When juicing leafy ingredients like celery and kale, do not collect more than 500g (approximately 2¼ cups) per session. For best results, disassemble and wash the top-set before juicing again.
- If leafy ingredients wrap around the Ultrasqueezer, open the Hopper and remove the fibers before continuing to juice.
- It's best to use ingredients with a higher amount of fluid, like apples or carrots.

## PREPARATION TIPS:

- Separate each stem. Cut outer stems to size.

## EXTRACTION TIPS:

- Slowly insert the prepared ingredients one at a time.
- Insert more ingredients after the previous ones have been completely extracted.
  - Roll leaves in spiral before inserting into the Juice Extractor.
  - Insert the leafy part of the ingredients first, then alternate between leafy parts and stems.
  - For ingredients like cilantro or wheatgrass, grab a handful and insert in a bundle.

## ⓘ CAUTION:

- The fibers from tough ingredients like celery can wrap around the Ultrasqueezer and affect the Juice Extractor's performance. Cut the stems to size.
- Foam can build up from juicing fibrous ingredients. Use strainer to remove the foam before serving.
- For ingredients like pineapple, slice off the rind of the pineapple and cut around the fibrous core. Cut the flesh of the pineapple to smaller pieces.
- Recommended amount of juicing per session is 500g (approximately 2¼ cups). When juicing more than this amount, wash the top-set before continuing to juice.



## Cleaning and Care

### NOTE:

Extract all the remaining pulp in the bowl before stopping the Juice Extractor.

For easier clean up, operate the Juice Extractor for an additional 30 seconds after the juice is extracted.

When the Hopper is stuck, press the REVERSE – OFF – FORWARD button in this order, switching back and forth 2 to 3 times to dislodge. Then place hands on the lower part of the Hopper and firmly press down simultaneously turning the Hopper counter clockwise to open.

**1** Switch OFF and unplug the power cord from the wall outlet.

**2** Turn the Hopper counter clockwise to open.

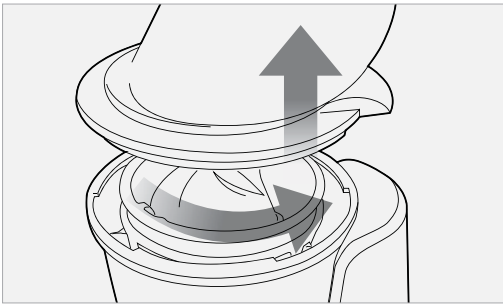

### NOTE:

When moving the appliance, do not lift by grabbing the Hopper. Always lift the appliance by grabbing the base or handle.

**3** Lift top set vertically off base.

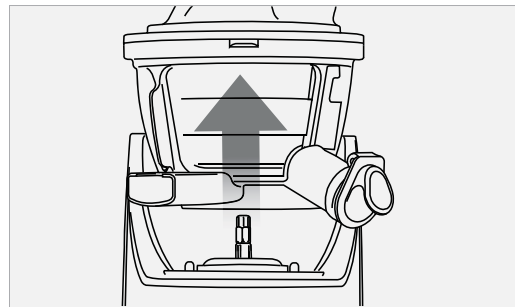

**4** Remove the Ultrasqueezer, strainer and rotation wiper unit from the bowl. Clean with provided brush.

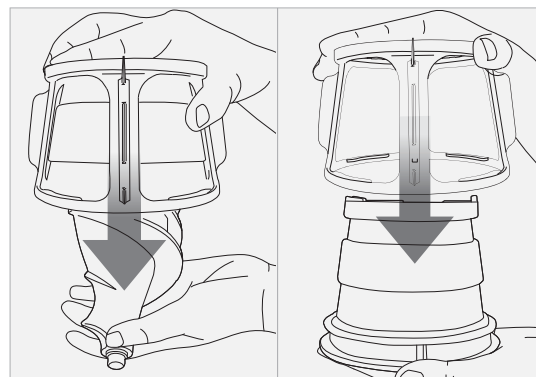

## ROYAL PRESTIGE® JUICE EXTRACTOR

**NOTE:**

Immediately clean the Juice Extractor after each use. If remaining residue in the Juice Extractor dries up, it can make disassembling and clean-up difficult. The excess buildup can cause poor performance in future uses.

For easier disassembly, place the Top-set in the sink and run water through it.

Thoroughly dry the bottom of the Ultrasqueezer where it connects to the metal cylinder shaft on the Base.

**5**

Under running water, clean the outside of the Ultrasqueezer with a dish scrub. Use the tip of a cleaning tool to push out any residue in the crevices on the bottom of the part.

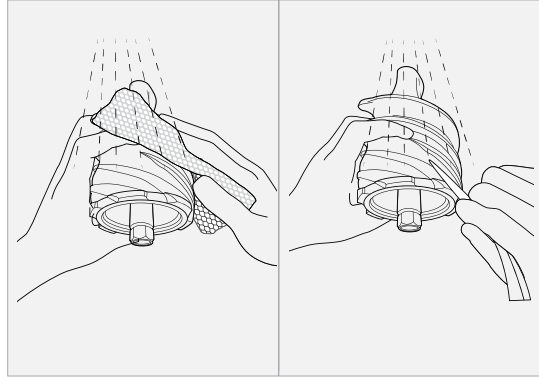
**TIP:**

Thoroughly clean the Ultrasqueezer, ensuring that it is clean without any residue.

Completely dry before using.

**NOTE:**

After juicing ingredients with seeds, make sure to thoroughly clean the bottom crevice of the Ultrasqueezer. If this area isn't properly cleaned, it can affect the balance between the Ultrasqueezer and the Strainer and damage the parts.





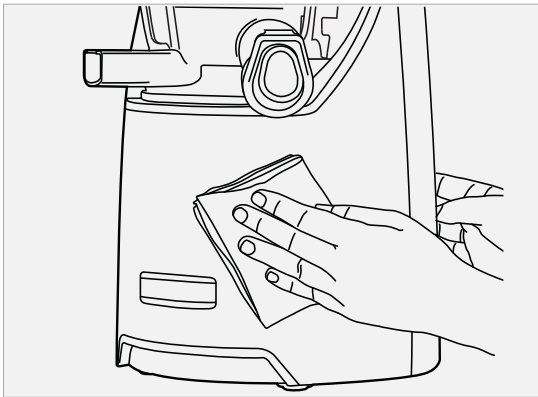

- 6** Clean the base with a soft damp towel and dry.

**TIP:** If the towel is dripping wet, make sure to squeeze out the excess liquid before using it on the Juice Extractor.

**NOTE:** Soak the bowl in a solution of warm water with baking soda or a little bit of bleach to clean the excess buildup.

## Quick Rinsing

- 1** With the cap closed, fill the juicing bowl with water and turn on the Juice Extractor.
- 2** Let it run for a moment. Open the cap and let the water run out of the bowl.

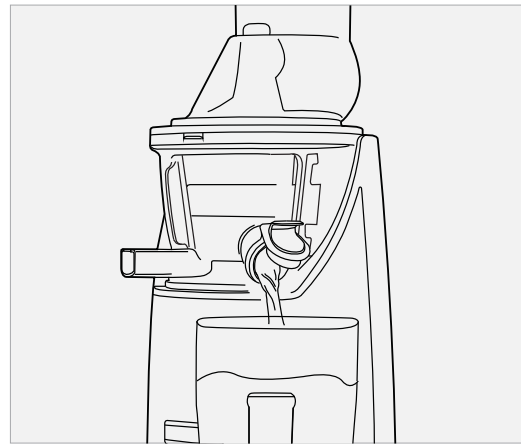

**TIP:**

It is not necessary to completely clean the Juice Extractor when making multiple juices during a single juicing session.

When finished juicing, always disassemble and clean thoroughly to prevent residue buildup.



# ROYAL PRESTIGE® JUICE EXTRACTOR

## How to Clean Silicone Parts

**Tip:** Clean the Rotation Wiper under running water. Thoroughly dry after cleaning.

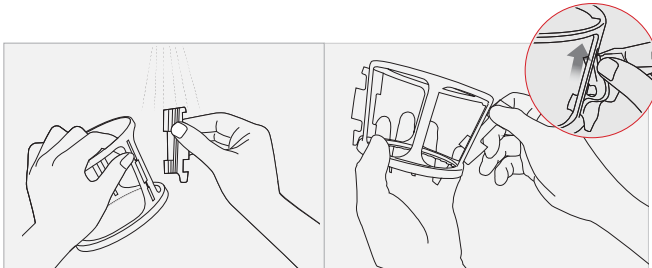

### SILICONE BRUSHES

Pull out the Silicone brushes from the rotation wiper to clean. After cleaning, insert into the slot with the tail pointing down as shown in the illustration.

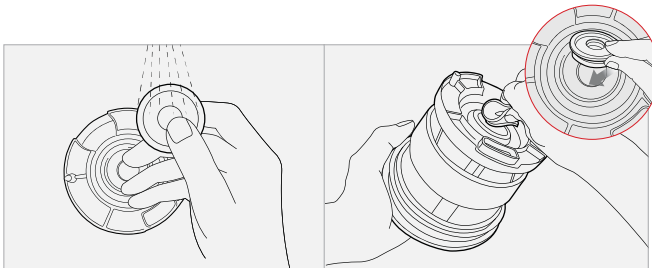

### SILICONE RING

Remove the silicone ring from the strainer to clean. After cleaning, push in the silicone ring with the smaller surface facing down.

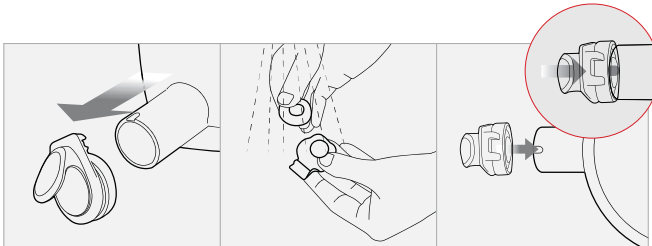

### CAP

Remove from the juice spout to clean. After cleaning, insert the silicone piece into the cap and attach the cap into the juice spout.



## How to Use the Rotating Brush

**Tip:** The rotating brush makes clean-up quick and easy. Completely dry after cleaning.

**Note:** Use the included Cleaning Brush to remove hard-to-reach bits after using the rotating brush.

- 1** Hold the rotating brush with one hand and insert the strainer into the brush.

**NOTE:** Insert the Strainer until you hear a click.

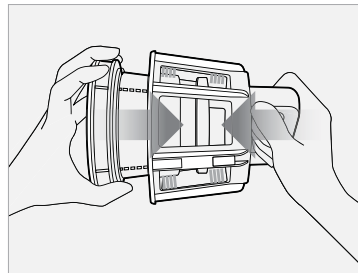

- 2** Under running water, rotate the rotating brush and the strainer in opposite directions to clean.

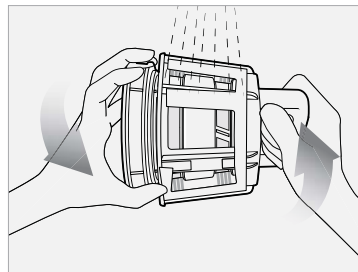

- 3** Thoroughly rinse the inside and outside of the strainer under running water.

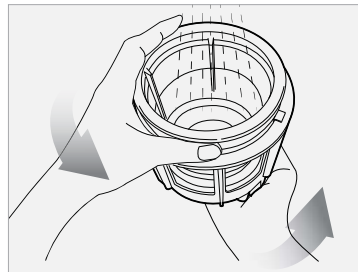

- 4** After cleaning, remove the strainer from the rotating brush. Dry before storing.

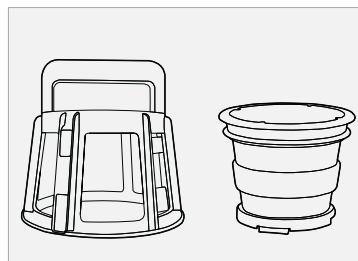

# ROYAL PRESTIGE® JUICE EXTRACTOR

## Troubleshooting Q&A

CONDITION	REASON	SOLUTION
<b>There is no power to the Juice Extractor</b>	Juice Extractor will not operate if parts are not assembled properly.	<ul style="list-style-type: none"> <li>• Check if the power cord is properly plugged in.</li> <li>• Check if the Hopper and the bowl are properly assembled.</li> <li>• Check to see if the Top-set and the Base are properly assembled.</li> </ul>
<b>Low juice yield</b>	<p>Each ingredient has different amounts of liquid that will yield different amounts of juice.</p> <p>If the ingredients are not fresh, they may contain reduced amounts of fluid, which will yield less juice.</p>	<ul style="list-style-type: none"> <li>• If the ingredient itself has low water content, it may help to soak it in water before juicing.</li> <li>• If juicing ingredients with small seeds, after a few servings, it may reduce the juice yield. For best results, disassemble and wash the Top-set in between juicing.</li> <li>• If there is seed residue on the bottom of the Strainer, this can affect Juice Extractor performance and the overall juice yield.</li> </ul>
<b>There is too much pulp in the juice</b>	When continuously juicing, and depending on the ingredient, the juice may contain a lot of fine pulp.	<ul style="list-style-type: none"> <li>• To reduce the fine pulp, clean the Top-set frequently and extract the pulp.</li> <li>• Use a mesh strainer and put the juice through it to collect the unwanted pulp.</li> <li>• If the Strainer and the Ultrasqueezer are damaged and affecting the Juice Extractor's performance, it is recommended the parts be replaced.</li> <li>• The lifetime of each part may vary depending on length and method of use and ingredients extracted. To order parts, see customer service information on page 24.</li> <li>• If too many ingredients are inserted at the same time, it may cause the Juice Extractor to stop frequently. This can lead to pulpy juice. Insert the ingredients slowly.</li> </ul>



# ROYAL PRESTIGE® JUICE EXTRACTOR

CONDITION	REASON	SOLUTION
<b>The Hopper will not close</b>	The Ultrasqueezer may not be properly inserted.	<ul style="list-style-type: none"> <li>• Make sure the Ultrasqueezer is pushed all the way into the Strainer for the Hopper to close properly.</li> </ul>
<b>Odd noise from the Juice Extractor</b>	<p>Check if the parts are assembled correctly.</p> <p>Operating the Juice Extractor without ingredients can cause damage to the Ultrasqueezer.</p> <p>If the size of ingredients is too large, friction noise will occur.</p> <p>The noise can occur if the Juice Extractor is operated on an uneven or slanted surface.</p>	<ul style="list-style-type: none"> <li>• Try reassembling the parts and listen for the odd noise.</li> <li>• Do not start the Juice Extractor unless there are ingredients and/or liquid in it.</li> <li>• The friction noise from the Ultrasqueezer and the Strainer will cease when ingredients are inserted into the Juice Extractor.</li> <li>• Check the size of the ingredients.</li> <li>• Place the Juice Extractor on a horizontally flat surface when operating.</li> </ul>
<b>The extracted pulp is very moist</b>	<p>During the very beginning of extraction, the pulp can be moister.</p> <p>Depending on the ingredient's condition, especially when the ingredient is not fresh, the juice can be extracted with the pulp.</p>	Select fresh ingredients.
<b>During operation, the bowl shakes</b>	<p>The Ultrasqueezer and the Strainer are set up to crush and squeeze the ingredients. It is normal for the Ultrasqueezer and the Strainer to vibrate.</p> <p>If the ingredient contains strong fiber, the vibration from the Top-set may be stronger.</p>	No action is required.
<b>Layers of separation in the juice</b>	Depending on the density of the ingredients, the extracted juice may show layers of different juices. It is different from separation due to oxidation caused by juicing with a high-speed Juice Extractor.	No action is required.



# ROYAL PRESTIGE® JUICE EXTRACTOR

CONDITION	REASON	SOLUTION
<b>During juicing, the Juice Extractor stopped</b>	<p>If too many ingredients are inserted at one time, this can cause the Juice Extractor to stop.</p> <p>The Juice Extractor stops due to the overload protection.</p> <p>Hard seeds can damage the Juice Extractor.</p>	<ul style="list-style-type: none"> <li>• Check the power cord and make sure it is plugged in correctly.</li> <li>• Check that all the parts are correctly assembled.</li> <li>• Press the REVERSE - OFF - FORWARD button in this order, switching back and forth 2 to 3 times.</li> <li>• The REVERSE setting will push the ingredients up, and the FORWARD setting will pull the ingredients down.</li> <li>• Let it cool for 30 minutes to 2 hours before juicing again.</li> <li>• If there are hard seeds within the ingredients, remove them before juicing.</li> </ul>
<b>The Hopper is stuck</b>	<p>If there is too much pulp in the top-set, this can cause the Hopper to not open.</p>	<ul style="list-style-type: none"> <li>• After juicing, let the Juice Extractor operate for another 30 seconds to extract the remaining pulp.</li> <li>• In this situation, press the REVERSE OFF - FORWARD button in this order, switching back and forth 2 to 3 times.</li> <li>• Pour water down the Hopper to rinse out the inside and then try opening it.</li> </ul>
<b>Fibers are wrapping around the Ultrasqueezer and are affecting performance</b>	<p>Ingredients with tough, long fibers are more difficult to juice.</p>	<ul style="list-style-type: none"> <li>• When juicing fibrous ingredients, do not collect more than 0.5 liter (approx. 2 ¼ cups) of juice. After collecting this quantity or less, clean the top-set completely before juicing again.</li> </ul>



# ROYAL PRESTIGE® JUICE EXTRACTOR

CONDITION	REASON	SOLUTION
<b>Discoloration of the plastic parts</b>	<p>After juicing, the remaining pulp inside the top-set can dry, which can make disassembling and cleaning hard. This can also affect the Juice Extractor's performance and color.</p> <p>Ingredients that are rich in carotenoids, such as carrots and spinach, may dye plastic parts.</p>	<ul style="list-style-type: none"> <li>• Clean Juice Extractor thoroughly after use.</li> <li>• The silicone pieces on the top-set can be detached to be thoroughly cleaned.</li> <li>• Rub vegetable oil on the dyed areas and use mild detergent to clean.</li> </ul> <p><b>NOTE:</b> Vegetable oil should only be used during clean-up for parts that are discolored. Do not use vegetable oil on the Ultrasqueezer or the strainer.</p>
<b>Using for purposes other than juicing</b>	<p>This Juice Extractor is designed to juice ingredients like fruits and vegetables.</p> <p>If vegetable/animal oil gets on the Ultrasqueezer or the strainer, this can affect the performance of the Juice Extractor and could result in damaged parts.</p>	<ul style="list-style-type: none"> <li>• Do not use the Juice Extractor for extracting vegetable oil.</li> <li>• Do not juice ingredients with high contents of vegetable/ animal oil.</li> </ul>

## Technical Information

<b>Product</b>	Juice Extractor
<b>Type</b>	Low speed compression Juice Extractor
<b>Model</b>	322NA (JU0026)
<b>Rated Voltage</b>	AC120-127V
<b>Rated Frequency</b>	60Hz
<b>Rated Power</b>	240 Watts
<b>Maximum Use</b>	Less than 30 minutes continuous
<b>Weight</b>	15 lbs
<b>Dimension</b>	<p>Height: 18.3 inches</p> <p>Length: 7.2 inches</p> <p>Width: 9.5 inches</p>
<b>Origin</b>	South Korea
<b>Manufacturer</b>	NUC Electronics Co., Ltd.



# ROYAL PRESTIGE® JUICE EXTRACTOR

For detailed warranty information,  
visit Royal Prestige® on the web at  
[www.royalprestige.com](http://www.royalprestige.com)



For warranty service, send the product to our Service Center:

**USA, CANADA, DOMINICAN REPUBLIC**

**HY CITE ENTERPRISES, LLC**

ROYAL PRESTIGE® SERVICE CENTER  
2115 PINEHURST DRIVE  
MIDDLETON, WI 53562

**PHONE: 1-800-279-3373**

**BILINGUAL (ENGLISH & SPANISH)**

**MÉXICO**

**HY CITE MÉXICO S. DE R.L. DE CV.**

AVENIDA JUAN GIL PRECIADO #2450  
NAVE 18 COLONIA EL TIGRE ZAPOPAN,  
JALISCO C.P. 45134

**PHONE: 01-800-111-1116**

**COLOMBIA**

**HY CITE ENTERPRISES**

**COLOMBIA S.A.S**

**DHL GLOBAL FORWARDING**

PARQUE INDUSTRIAL SAN CARLOS II,  
KILÓMETRO 2.5 VÍA FONTIBÓN  
FUNZA CUNDINAMARCA, COLOMBIA

**PHONE: 01-800-018-7449**

**PERÚ**

**HY CITE PERÚ S.R.L.**

CALLE. CANTUARÍAS #160, 170, 176  
OFICINA #702 – EDIFICIO CANTUARÍAS  
MIRAFLORES, LIMA-PERÚ

**PHONE: (511) 243-7756**

**/ (511) 243-7768**

**BRASIL**

**HY CITE PARTICIPAÇÕES**

**BRASIL LTDA.**

COMÉRCIO E IMPORTAÇÃO  
DE UTILIDADES DOMÉSTICAS LTDA.  
CENTRO DE ATENÇÃO  
ALAMEDA ARAGUAIA N.º 3814 BARUERI - SP

CEP: 06455-000

**PHONE: (11) 4191-5026**

**ARGENTINA**

**HY CITE BA S.R.L.**

SUIPACHA 552, PISO 1,  
CAPITAL FEDERAL, BUENOS AIRES,  
ARGENTINA, C.P. 1008

**PHONE: 0-800-444-2904**



**ROYAL  
PRESTIGE®**